



SB2.5 RECUMBENT BIKE OWNER'S MANUAL

PLEASE CAREFULLY READ THIS ENTIRE MANUAL BEFORE OPERATING YOUR NEW RECUMBENT BIKE



Congratulations On Your New Bike and Welcome to the XTERRA Fitness Family!

Thank you for your purchase of this quality fitness bike from **XTERRA Fitness**. Your new fitness bike has been manufactured by one of the leading fitness manufacturers in the world. **XTERRA Fitness** will do all we can to make your ownership experience as pleasant as possible for many years to come. If you have questions, or if parts are missing or damaged, or you require customer service, call (870) 336-4286. Please have your model number and serial number handy when you call.

Please take a moment to record where you purchased your machine, as well as the date of purchase for future reference. We appreciate your confidence in **XTERRA Fitness** and we will always remember that you are the reason that we are in business. Please complete and mail your registration card today and enjoy your new fitness bike.

Yours in Health,
XTERRA Fitness

Table Of Contents

| | |
|---------------------------------|----|
| Product Registration | 1 |
| Important Safety Instructions | 2 |
| SB2.5 Assembly Instructions | 5 |
| Operation of Your Console | 8 |
| Program Operation | 11 |
| Manufacturer's Limited Warranty | 17 |

Product Registration

Purchase Location _____

Purchase Date _____

Record Your Serial Number

Please record the Serial Number of this fitness product in the space provided below.

Serial Number _____

Register Your Purchase

The self-addressed product registration card must be completed in full and returned to **Xterra Fitness**. You can also go to www.xterrafitness.com/warrantyreg.html to register online.

ATTENTION

THIS FITNESS BIKE IS INTENDED FOR **RESIDENTIAL USE ONLY** AND IS WARRANTED FOR THE APPLICATION. ANY OTHER APPLICATION **VOIDS** THIS WARRANTY IN ITS ENTIRETY.

Power

This product uses an external power supply. The power supply must be plugged into the power jack, located on the front of the unit near the stabilizer tube. Next, plug the power supply into the appropriate wall outlet. When not in use, it is recommended to unplug the power supply from the wall outlet.

IMPORTANT: If the product has been exposed to cold temperatures, allow the product sit in room temperature to warm up before plugging in the power supply. Failure to do so may result in damage to the display or electronic components.

IMPORTANT: Do not operate the product if the power supply, its plug, or its cord has been damaged.



Important Safety Instructions

When using an electrical appliance, basic precautions should always be followed, including the following:

Read all instructions before using this appliance.

DANGER - To reduce the risk of electric shock:

1. Always unplug this appliance from the electrical outlet immediately after using and before cleaning.

WARNING - To reduce the risk of burns, fire electric shock, or injury to persons:

1. An appliance should never be left unattended when plugged in. Unplug from outlet when not in use, and before putting on or taking off parts.
2. Do not operate under blanket or pillow. Excessive heating can occur and cause fire, electric shock, or injury to persons.
3. This exercise equipment is not intended for use by persons with reduced physical, sensory or mental capabilities, or lack of experience and knowledge.
4. Use this appliance only for its intended use as described in this manual. Do not use attachments not recommended by the manufacturer.
5. Never operate this appliance if it has a damaged cord or plug, if it is not working properly, if it has been dropped or damaged, or dropped into water. Return the appliance to a service center for examination and repair.
6. Do not carry this appliance by supply cord or use cord as a handle.
7. Keep the cord away from heated surfaces.
8. Never operate the appliance with the air openings blocked. Keep the air openings free of lint, hair, and the like.
9. Never drop or insert any object into any opening.
10. Do not use outdoors.
11. Do not operate where aerosol (spray) products are being use or where oxygen is being administered.
12. Connect this appliance to a properly grounded outlet only.
13. The appliance is intended for household use.



WARNING: This product can expose you to chemicals including Toluene and Acrylamide which are known to the State of California to cause cancer and birth defects or other reproductive harm. For more information go to www.P65Warnings.ca.gov

Fitness Equipment Safety Instructions

- To disconnect, turn all controls to the off position, then remove the plug from the outlet.
- Do not operate equipment on deeply padded, plush or shag carpet. Damage to both carpet and equipment may result.
- Before beginning this or any exercise program, consult a physician. This is especially important for persons over the age of 35 or persons with pre-existing health conditions.
- Keep hands away from all moving parts.
- The pulse sensors are not medical devices. Various factors, including the user's movement, may affect the accuracy of heart rate readings. The pulse sensors are intended only as exercise aids in determining heart rate trends in general.
- Do not attempt to use your equipment for any purpose other than for the purpose it is intended.
- Wear proper shoes. High heels, dress shoes, sandals or bare feet are not suitable for use on your equipment. Quality athletic shoes are recommended to avoid leg fatigue.



Failure to follow all guidelines may compromise the effectiveness of the exercise experience, expose yourself (and possibly others) to injury, and reduce the longevity of the equipment.

SAVE THESE INSTRUCTIONS - THINK SAFETY!

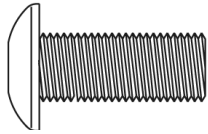
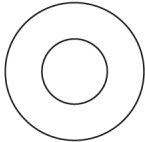
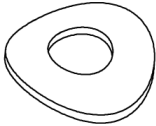

CAUTION!! Please be careful when unpacking the carton.

SB2.5r Assembly Pack Checklist

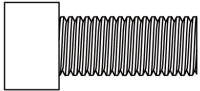
Hardware Step 1

| | | | |
|---|---|--|---|
|  |  |  |  |
| #32. 5/16" x 3/4" Button Head Socket Bolt (6 pcs) | #33. 5/16" Flat Washer (10 pcs) | #34. 5/16" Curved Washer (1 pc) | #35. 5/16" Split Washer (11 pcs) |
|  |  | | |
| #41. M5 x 12mm Phillips Head Screw (4 pcs) | #112. 5/16" x 3/4" Socket Head Cap Bolt (5 pcs) | | |

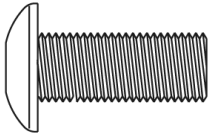
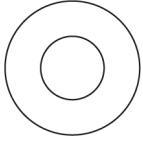
Hardware Step 2

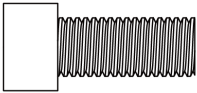
| | | | |
|---|---|---|--|
|  |  |  | |
| #32. 5/16" x 3/4" Button Head Socket Bolt (4 pcs) | #33. 5/16" Flat Washer (4 pcs) | #35. 5/16" Split Washer (4 pc) | |
|  | | | |
| #112. 5/16" x 3/4" Socket Head Cap Bolt (4 pcs) | | | |

Hardware Step 3

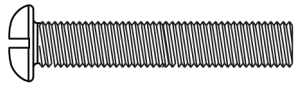

#55. M6 x 35mm
Phillips Head Screw
(4 pcs)

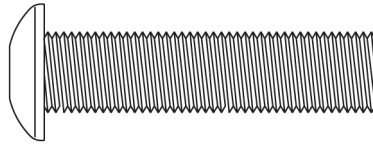

#61. 3/8" x 1-3/4"
Button Head Socket
Bolt (6 pcs)

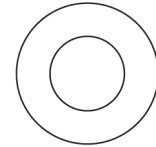

#62. 3/8"
Flat Washer
(6 pcs)



#63. 3/8" x 7T
Nyloc Nut
(6 pcs)

Assembly Tools

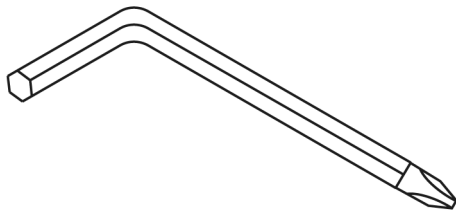

#68. Combination M5 Allen Wrench
& Phillips Head Screw Driver

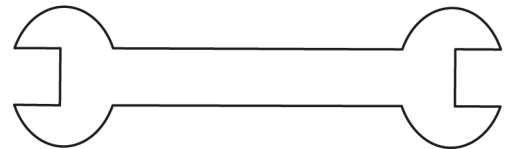

#69. 14/15mm Wrench

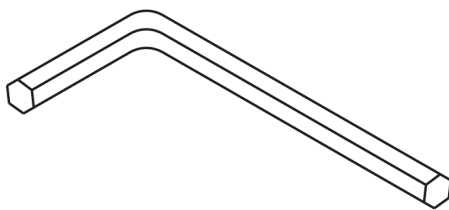

#92. 6mm L Allen Wrench

SB2.5r Assembly Instructions

1

Frame, Console Mast & Console

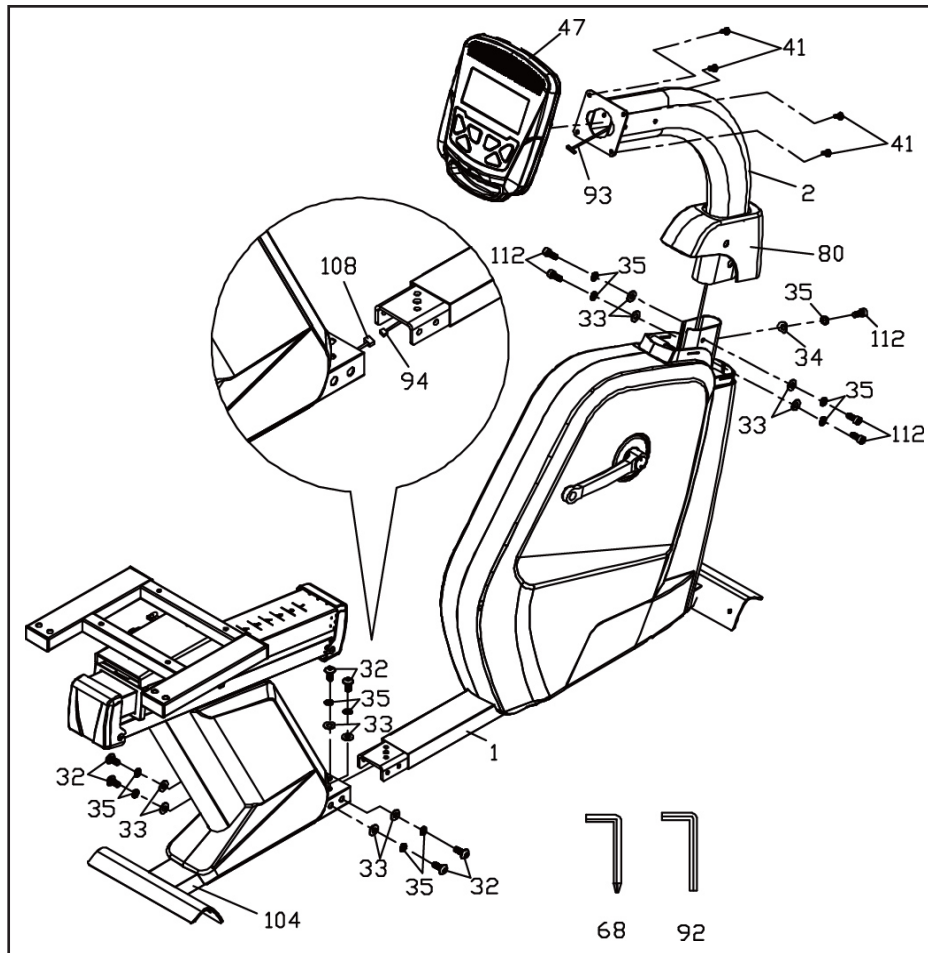

Hardware Step 1

- #32. 5/16" x 3/4" Button Head Socket Bolt (6 pcs)
- #33. 5/16" Flat Washer (10 pcs)
- #34. 5/16" Curved Washer (1 pc)
- #35. 5/16" Split Washer (11 pcs)
- #41. M5 x 12mm Phillips Head Screw (4 pcs)
- #112. 5/16" x 3/4" Socket Head Cap Bolt (5 pcs)

1. First, connect Hand pulse Wire (Middle) (108) and Hand pulse Wire (Upper) (94). Then join Rear Main Frame (104) and Front Main Frame (1) together using the Combination M5 Allen Wrench & Phillips Head Screw Driver (68) to tighten six Button Head Socket Bolts (32), six split washers (35) together with six Flat Washers (33).
2. Locate the Console Mast (2) and slide on the Console Mast Cover (80). Make sure the cover is facing the correct direction, as shown below, before sliding onto mast. Install the wiring harness into the bottom of the mast and out the top. Be careful when installing the console mast to the main frame so as not to pinch or cut the wiring harness, damage to the console may occur.
3. Install the console mast on the mainframe using the 6mm Allen Wrench (92) to tighten five Socket Head Cap Bolts (112), five Split Washers (35), four Flat Washers (33) and one Curved Washer (34). Snap the Console Mast Cover (80) down onto the plastic side covers.
4. Connect the cable (93) to the Console Assembly (47), then install the console onto the Console Mast (2) with four Phillips head screws (41). using the Phillips Head Screw Driver (68) to tighten

2 Handlebars, Pedals & Stabilizer Tubes

Hardware Step 2

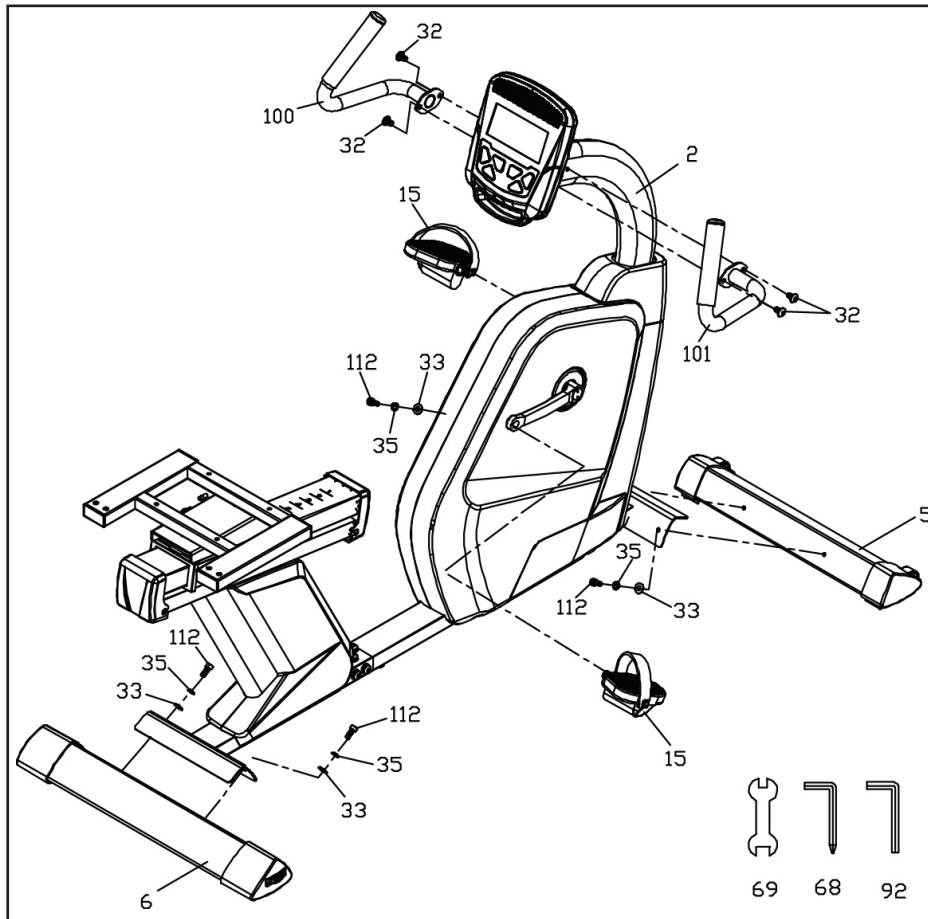

- #32. 5/16" x 3/4" Button Head Socket Bolt (4 pcs)
- #33. 5/16" Flat Washer (4 pcs)
- #35. 5/16" Split Washer (4 pcs)
- #112. 5/16" x 3/4" Socket Head Cap Bolt (4 pcs)

1. Use the 6mm Allen Wrench (92) to secure the front and rear stabilizers (5 & 6) on the mounting brackets with four Socket Head Cap Bolts (112), four split washers (35), and four flat washers (33).
2. Use 14/15mm Wrench (69) to tighten the pedals (15 left and right) to the crank axle. The left pedal is a reverse thread and will screw in a counterclockwise direction. The pedals are marked with an R or L on the end of the threaded pedal axle. Make sure to tighten the pedals firmly or a clicking noise can occur during pedaling. It may be necessary to retighten the pedals after use, if clicking occurs.
3. Attach the left and right handles (100, 101) to the Console Mast (2) with four Button Head Socket Bolts (32) using the Combination M5 Allen Wrench & Phillips Head Screw Driver (68).

3 Seat & Rear Handlebars

Hardware Step 3

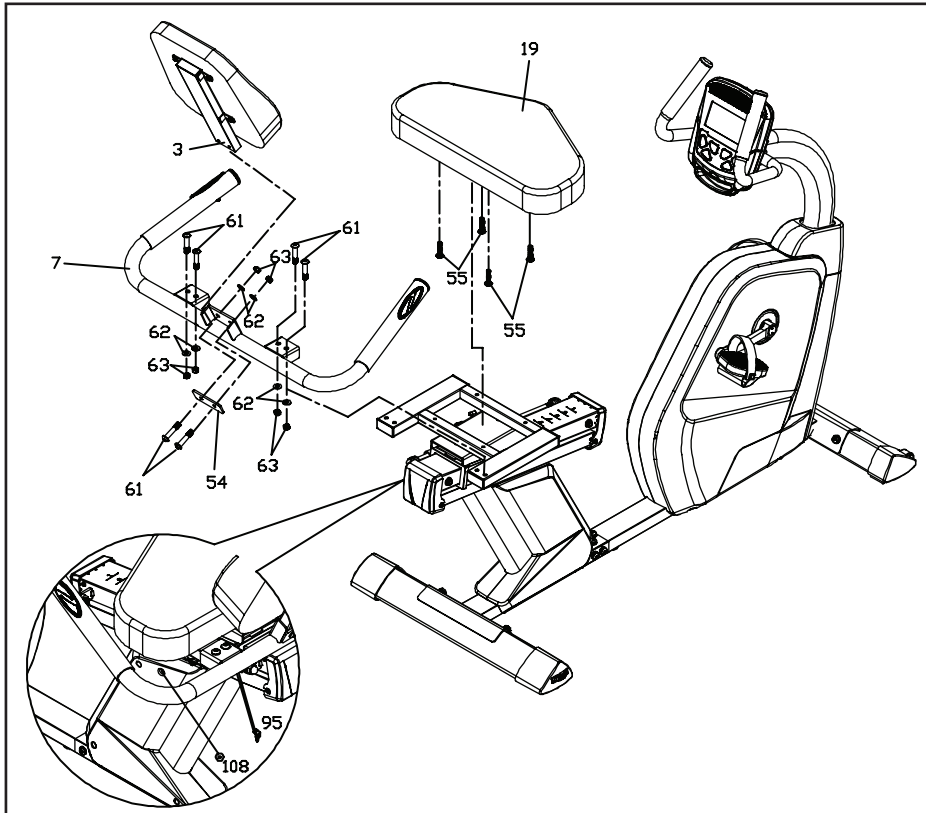

- #55. M6 x 35mm Phillips Head Screw (4 pcs)
- #61. 3/8" x 1-3/4" Button Head Socket Bolt (6 pcs)
- #62. 3/8" Flat Washer (6 pcs)
- #63. 3/8" x 7T Nyloc Nut (6 pcs)

1. Secure the Seat (**19**) on the sliding seat carriage with four Phillips head screws (**55**). Tighten with the Combination M5 Allen Wrench & Phillips Head Screw Driver (**68**). Install Seat Handle Bar (**7**) on the sliding seat carriage by using M6 L Allen Wrench (**92**) with four Button Head Socket Bolts (**61**), going through the Seat Handle Bar (**7**), four Flat Washers (**62**), and four Nyloc Nuts (**63**). Tighten with the 14/15mm Wrench (**69**).
2. Install Seat Back Bracket (**3**) on the Seat Handle Bar (**7**) with by using M6 L Allen Wrench (**92**) two Button Head Socket Bolts (**61**) going through the Seat Back Mounting Plate (**54**), then two Flat Washers (**62**), and two Nyloc Nuts (**63**). Tighten with the 14/15mm Wrench (**69**).
3. Connect the hand pulse connector (**108** and **95**) as shown in the inset picture below.

Operation of Your Console

SB2.5 Console



Key Functions

START / STOP:

1. Starts & Pauses workouts.
2. Starts body fat measurement.
3. Holding key for 3 seconds will reset all functions and values to zero.

DOWN: Decreases value of selected workout parameter: TIME, DISTANCE, etc. During the workout it will decrease the resistance load.

UP: Increases value of selected workout parameter. During the workout it will increase the resistance load.

ENTER: To input desired value or work out mode.

RECOVERY: Press to enter into heart rate Recovery function. Only works when the computer is receiving a heart rate value. Recovery is an indication of Fitness Level. It is a one minute measurement taken immediately after and exercise session and provides a score from 1 to 6. A score of 1 is an indication of a high level of fitness and a score of 6 indicates poor condition.

MODE: Press to switch display from RPM to SPEED, ODO to DIST, WATT to CALORIES.

Functions

SPEED: Displays current training speed. Maximum speed is 99.9 KM/H or MILE/H.

RPM: Displays current pedal rotations per minute.

TIME: Accumulates workout time from 00:00 to 99:59. Or users can preset the target time desired.

DIST: Accumulates the workout distance from 0.00 up to 999.9 KM or Mile. Or users can preset the target distance they want to reach.

ODO: Displays the total accumulated distance from 0.0 to 999.9KM or Mile.

CAL: Accumulates the calories burned from 0 to 9999. Or users can preset the target Calories they want to burn.

WATT: Displays current watt.

HEART RATE: Displays the current heart rate in beats per minute.

TARGET H. R.: Users can preset their Target Heart Rate.

PROGRAM: There are 24 different programs to choose from for training.

LEVEL: The programs have 24 levels of work displayed in 8 bars in each column. Each column represents 1 minute workout (Unless time is changed to a new value for count down) and each bar represents 3 levels of work.

Music: There is an audio-input port on the top of the monitor. Users can connect an MP3, smart phone or other audio source to the port.

Workout Selection

After power-up, use the UP / DOWN keys to select a workout program then pressing ENTER. There are 7 basic workout programs: **Manual, Pre-Programs, Watt Program, Body Fat Program, Target Heart Rate program, Heart Rate Control Program and User Program.**

Workout Parameter

(TIME/DISTANCE/CALORIES/WATT/TARGET HEART RATE)

Setting Workout Parameters

After selecting desired workout program (Manual, Pre-set Programs, Watt Program, Target Heart Rate, Heart Rate Control and User Program) you may pre-set several workout parameters for desired results.

***Note:** Some parameters are not adjustable in certain programs. Time and Distance can not be set up in the same workout.*

Once a program has been selected pressing ENTER will make "Time" parameter flash. Using UP / DOWN KEY you may set the desired time value. Press ENTER KEY to input value. Flashing prompt will move to the next parameter. Continue use of UP / DOWN KEY. Press START / STOP to start workout.

More About Workout Parameters

| Parameter | Setting Range | Default Value | Increment / Decrement | Description |
|-----------|---------------|---------------|-----------------------|--|
| Time | 0:00 - 99:00 | 00:00 | ± 1:00 | <ol style="list-style-type: none"> 1. When display is 0:00, Time will count up. 2. When Time is 1:00 - 99:00, it will count down to 0:00. |
| Distance | 0.00 - 999.0 | 0.00 | ± 1.0 | <ol style="list-style-type: none"> 1. When display is 0.00, Distance will count up. 2. When Distance is 1.0 - 999.0, it will count down to 0.00. |
| Calories | 0 - 9995 | 0 | ± 5 | <ol style="list-style-type: none"> 1. When display is 0, Calories will count up. 2. When Calories is 5 - 9995, it will count down to 0. |
| Watt | 40-250 | 100 | ± 5 | User can set watt value only in Watt control program. |
| Age | 10-99 | 30 | ± 1 | Target Heart Rate will be based on Age. When heart rate exceeds Target Heart Rate, the number of heart rate will flash. |
| Pulse | 60-220 | 90 | ± 1 | Setting Parameters for Target Heart Rate. |

Program Operation

Manual Program

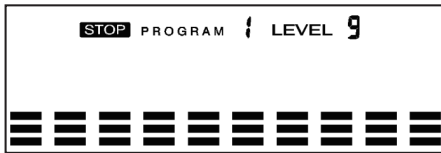

Setting Parameters for the Manual Program

Select **Manual** using UP / DOWN KEY then press the ENTER KEY. The first parameter, "Time" will flash so value can be adjusted using UP / DOWN KEY. Press ENTER KEY to save value & move to next parameter to be adjusted. **** (If user sets up the target time to workout then the next parameter of Distance can not be adjusted)** Continue through all desired parameters, pressing START / STOP to start workout.

Note: When any One of the workout parameters counts down to zero the console emits a beep sound and the workout stops automatically. Press START KEY to continue the workout to reach the unfinished workout goals set.

Pre-Set Programs

There are 12 pre-set program profiles ready for use ROLLING, VALLEY, FAT BURN, RAMP, STEPS, OBSTACLE, INTERVALS, PLATEAU, CLIMBING, OFF ROAD, HILL, FASTREK. All program profiles have 24 levels of resistance. See page 12 to view the profiles.

Setting Parameters for Pre-Set Programs

Select one of pre-set programs using UP / DOWN KEY then pressing ENTER KEY. The first parameter, "Time" will flash indicating the value can be adjusted using UP / DOWN KEY. Press ENTER KEY to save value & move to next parameter to be adjusted. Continue through all desired parameters, pressing START / STOP to start workout.

Workout in any Pre-Set Program

Users can exercise at different levels of intensity in different intervals as the profiles flash. Users may adjust the resistance level using the UP / DOWN keys during the workout.

Note: If user sets up the target time to workout then the next parameter of Distance can not be adjusted. When any one of the workout parameters counts down to zero the console emits a beep sound and the workout stops automatically. Press START KEY to continue the workout to reach the unfinished workout goals set.

Pre-Set Programs (P2 - P13)

STOP PROGRAM 2 LEVEL 9



ROLLING

STOP PROGRAM 3 LEVEL 15



VALLEY

STOP PROGRAM 4 LEVEL 3



FAT BURN

STOP PROGRAM 5 LEVEL 3



RAMP

STOP PROGRAM 6 LEVEL 6



STEPS

STOP PROGRAM 7 LEVEL 6



OBSTACLE

STOP PROGRAM 8 LEVEL 9



INTERVALS

STOP PROGRAM 9 LEVEL 6



PLATEAU

STOP PROGRAM 10 LEVEL 6



CLIMBING

STOP PROGRAM 11 LEVEL 9



OFF ROAD

STOP PROGRAM 12 LEVEL 9



HILL

STOP PROGRAM 13 LEVEL 6



FASTREK

Watt Control Program

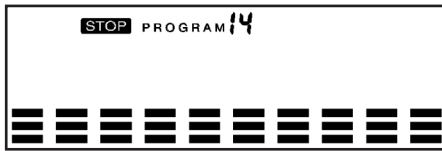

Setting Parameters for Watt Control Programs

Select **Watt Control Program** using UP / DOWN KEY then press ENTER KEY. The first parameter “Time” will flash indicating the value can be adjusted using UP / DOWN KEY. Press ENTER KEY to save value & move to next parameter to be adjusted. **** (If user sets up the target time to workout, then the next parameter of Distance can not be adjusted)** Continue through all desired parameters, pressing START / STOP to start workout.

***Note:** When any one of the workout parameters counts down to zero the console emits a beep sound and the workout stops automatically. Press START KEY to continue the workout to reach the unfinished workout goals set. The computer will adjust the resistance load automatically depending on the speed to maintain a constant watt value. User can use UP / DOWN key to adjust the watt value during workout.*

Body Fat Measurement



Setting Data for Body Fat

1. Select **Body Fat** using UP / DOWN KEY then pressing ENTER.
2. “Male” will flash indicating the Gender can be adjusted using UP / DOWN KEY. Press ENTER to save gender setting & move to next setting.
3. A Height of “175” will flash indicating the Height can be adjusted using UP / DOWN KEY. Press ENTER KEY to save value & move to next setting.
4. A Weight of “75” will flash indicating the Weight can be adjusted using the UP / DOWN KEY. Press ENTER KEY to save value & move to next setting.
5. An Age of “30” will flash indicating the Age can be adjusted using UP / DOWN KEY. Press ENTER to save value.
6. Press START / STOP to start measurement. Please be sure to grasp the hand pulse grips. After 15 seconds the display will show Body Fat %, BMR, BMI & BODY TYPE.
7. Press START / STOP KEY to return the main Display.

***Body Types:** There are 9 possible body types according to the FAT% calculated. Type 1 is from 5% to 9%. Type 2 is from 10% to 14%. Type 3 is from 15% to 19%. Type 4 is from 20% to 24%. Type 5 is from 25% to 29%. Type 6 is from 30% to 34%. Type 7 is from 35% to 39%. Type 8 is from 40% to 44%. Type 9 is from 45% to 50%.*

***BMR:** Basal Metabolic Rate is the amount of daily energy expended at rest.*

***BMI:** Body Mass Index is a general body type based on height and weight.*

User Program

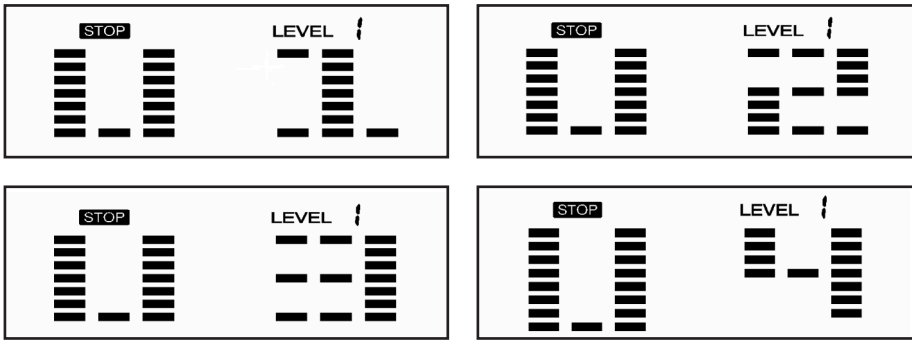

Four User Programs allow the user to create their own personal programs.

Setting Parameters for User Programs

Select “User” using UP / DOWN KEY then press ENTER KEY. The first parameter, “Time” will flash indicating the value can be adjusted using UP / DOWN KEY. Press ENTER KEY to save value & move to next parameter to be adjusted. **** (If user sets up the target time to workout, then the next parameter of Distance can not be adjusted)** Continue through all desired parameters.

After completing parameter set up, row 1 of the profile will be flashing. Use UP / DOWN KEY to adjust level then press ENTER until finished (10 times total). Press START / STOP to start workout.

Note: When any one of the workout parameters counts down to zero the console emits a beep sound and the workout stops automatically. Press START KEY to continue the workout to reach the unfinished workout goals set.

Heart Rate Training Programs

There are two ways to communicate your heart rate to the console. Use the contact heart rate grips and keep a consistent and firm grip, or buy an optional heart rate strap that transmits your pulse wirelessly to the console. The heart rate strap is a more accurate measurement of your actual heart rate.

Wearing The Chest Strap

1. Attach the transmitter to the elastic strap using the locking parts.
2. Adjust the strap as tightly as possible as long as the strap is not too tight to remain comfortable.
3. Position the transmitter with the logo centered in the middle of your torso facing away from your chest (some people must position the transmitter slightly left of center). Attach the final end of the elastic strap by inserting the round end and, using the locking parts, secure the transmitter and strap around your chest.
4. Position the transmitter directly below the pectoral muscles.
5. Sweat is the best conductor to measure very minute heart beat electrical signals.

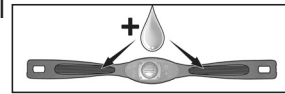
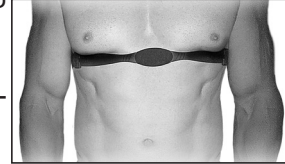

However, plain water can also be used to pre-wet the electrodes (2 ribbed oval areas on the reverse side of the belt and both sides of the transmitter). It's also recommended that you wear the transmitter strap a few minutes before your work out. Some users, because of body chemistry, have a more difficult time in achieving a strong, steady signal at the beginning. After "warming up", this problem lessens. As noted, wearing clothing over the transmitter/strap doesn't affect performance.

6. Your workout must be within range - distance between transmitter/receiver – to achieve a strong steady signal. The length of range may vary somewhat but generally stay close enough to the console to maintain good, strong, reliable readings. Wearing the transmitter directly on bare skin assures you of proper operation. If you wish, you may wear the transmitter over a shirt. To do so, wet the areas of the shirt that the electrodes will rest upon.

Note: The transmitter is automatically activated when it detects activity from the user's heart. Additionally, it automatically deactivates when it does not receive any activity. Although the transmitter is water resistant, moisture can have the effect of creating false signals, so you should take precautions to completely dry the transmitter after use to prolong battery life (estimated transmitter battery life is 2500 hours).

Erratic Operation

Caution! Do not use this treadmill for Heart Rate programs unless a steady, solid Actual Heart Rate value is being displayed. High, wild, random numbers being displayed indicate a problem.

Areas to look for interference which may cause erratic heart rate:

1. Microwave ovens, TV's, small appliances, etc.
2. Fluorescent lights.
3. Some household security systems.
4. Perimeter fence for a pet.
5. Some people have problems with the transmitter picking up a signal from their skin. If you have problems try wearing the transmitter upside down. Normally the transmitter will be oriented so the XTERRA Fitness logo is right side up.
6. The antenna that picks up your heart rate is very sensitive. If there is an outside noise source, turning the whole machine 90 degrees may de-tune the interference.
7. Another Individual wearing a transmitter within 3' of your machine's console.

If you continue to experience problems contact your us.

Target Heart Rate Program

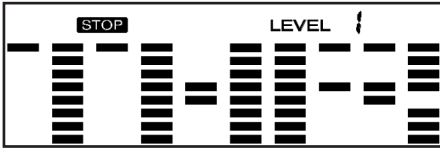

Setting Parameters for the Target Heart Rate Program

Select **Target HR** using UP / DOWN KEY then press ENTER KEY. The first parameter "Time" will flash indicating the value can be adjusted using UP / DOWN KEY. Press ENTER KEY to save value & move to next parameter to be adjusted. ****If user sets up the target time to workout, then the next parameter of Distance can not be adjusted**) Continue through all desired parameters, pressing START / STOP to start workout.

Note: If your Pulse measurement is above or below (± 5) the TARGET HR setting, the computer will adjust the resistance load automatically; it will check approximately every 10 seconds. If the heart rate signal disappears, the computer will keep the resistance load constant for 60 seconds then it will decrease the resistance load 1 level every 10s.

When any one of the workout parameters counts down to zero the console emits a beep sound and the workout stops automatically. Press START KEY to continue the workout to reach the unfinished workout goals set.

Heart Rate Control Program

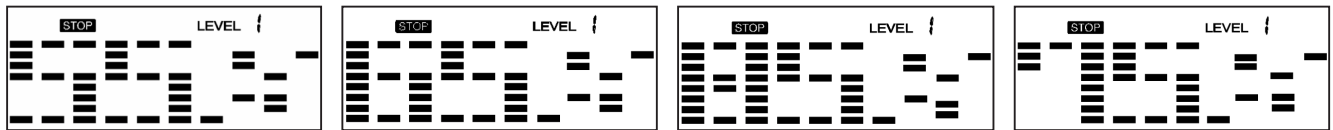

There are 4 selections for target pulse:

- HRC- 55% TARGET H.R= 55% of (220-AGE)
- HRC - 65% TARGET H.R= 65% of (220-AGE)
- HRC - 75% TARGET H.R= 75% of (220-AGE)
- HRC - 85% TARGET H.R= 85% of (220-AGE)

Setting Parameters for Heart Rate Control Programs

Select one of the **Heart Rate Control Programs** using UP / DOWN KEY then press ENTER KEY. The first parameter "Time" will flash indicating the value can be adjusted using UP / DOWN KEY. Press ENTER KEY to save value & move to next parameter to be adjusted. ****If user sets up the target time to workout, then the next parameter of Distance can not be adjusted**) Continue through all desired parameters, pressing START / STOP to start workout.

Note: If your Pulse measurement is above or below (± 5) the Target HR setting, the computer will adjust the resistance load automatically; it will check approximately every 10 seconds. If the heart rate signal disappears, the computer will keep the resistance load constant for 60 seconds then it will decrease the resistance load 1 level every 10 seconds.

When any one of the workout parameters counts down to zero the console emits a beep sound and the workout stops automatically. Press START KEY to continue the workout to reach the unfinished workout goals set.

Manufacturer's Limited Warranty

Effective July 06, 2020 - BIKE LIMITED WARRANTY

XTERRA Fitness Inc. warrants all its home use bike parts for a period of time listed below, from the date of retail sale, as determined by a sales receipt or in the absence of a sales receipt, eighteen (18) months from the original factory shipping date. XTERRA Fitness's responsibilities include providing new or remanufactured parts, at XTERRA Fitness's option, and technical support to our independent dealers and servicing organizations. In the absence of a dealer or service organization, these warranties will be administered by XTERRA Fitness directly to a consumer. The warranty period applies to the following components:

Home Use Limited Warranty

| | |
|---------|--------|
| Frame | Parts |
| 5 Years | 1 Year |

NORMAL RESPONSIBILITIES OF THE CONSUMER

This warranty applies only to products in ordinary household use. The consumer is responsible for the items listed below:

1. The warranty registration card must be completed and returned to the address listed on the card within 10 days of the original purchase to validate the manufacturer's limited warranty or register online at <http://www.xterrafitness.com/warrantyreg.html>.
2. Proper use of the bike in accordance with the instructions provided in this manual, including maintenance.
3. Proper connection to a power supply of sufficient voltage, replacement of blown fuses, repair of loose connections or defects in house/facility wiring.
4. Expenses for making the bike accessible for servicing, including any item that was not part of the bike at the time it was shipped from the factory.
5. Damages to the bike finish during shipping, installation or following installation.

EXCLUSIONS

This warranty does not cover the following:

1. CONSEQUENTIAL, COLLATERAL, OR INCIDENTAL DAMAGES SUCH AS PROPERTY DAMAGE AND INCIDENTAL EXPENSES RESULTING FROM ANY BREACH OF THIS WRITTEN OR ANY IMPLIED WARRANTY. Note: Some states do not allow the exclusion or limitation of incidental or consequential damages, so this limitation or exclusion may not apply to you.
2. Damages caused by services performed by persons other than authorized XTERRA Fitness service companies, use of parts other than original XTERRA Fitness parts, or external causes such as alterations, modifications, abuse, misuse, accident, improper maintenance, inadequate power supply, or acts of God.
3. Products with original serial numbers that have been removed or altered.
4. Products that have been; sold, transferred, bartered, or given to a third party.
5. Products that are used as store display models.
6. Products that do not have a warranty registration on file at XTERRA Fitness, Inc. XTERRA Fitness reserves the right to request proof of purchase if no warranty record exists for the product.
7. THIS WARRANTY IS EXPRESSLY IN LIEU OF ALL OTHER WARRANTIES EXPRESSED OR IMPLIED, INCLUDING THE WARRANTIES OF MERCHANTABILITY AND/OR FITNESS FOR A PARTICULAR PURPOSE.
8. Product use in any environment other than a residential setting.

SERVICE

Keep your bill of sale. Twelve (12) months from the date on the bill of sale or eighteen (18) months from the date of factory shipping as determined by the serial number establishes the warranty period should service be required. If service is performed, it is in your best interest to obtain and keep all receipts. This written warranty gives you specific legal rights. You may also have other rights that vary from state to state. Service under this warranty must be obtained by following these steps, in order:

1. Contact your selling authorized XTERRA Fitness dealer. OR
2. Contact your local authorized XTERRA Fitness service organization.
3. If there is a question as to where to obtain service, contact our service department at (870) 336-4286.
4. XTERRA Fitness's obligation under this warranty is limited to repairing or replacing, at XTERRA Fitness's option, the product through one of our authorized service centers. All repairs must be preauthorized by XTERRA Fitness. If the product is shipped to a service center freight charges to and from the service center will be the customer's responsibility. For replacement parts shipped while the product is under warranty, the customer will be responsible for shipping and handling charges.
5. The owner is responsible for adequate packaging upon return to XTERRA Fitness. XTERRA Fitness is not responsible for damages in shipping. Make all freight damage claims with the appropriate freight carrier. DO NOT SHIP ANY UNIT TO OUR FACTORY WITHOUT A RETURN AUTHORIZATION NUMBER. All units arriving without a return authorization number will be refused.
6. For any further information, or to contact our service department by mail, send your correspondence to:

XTERRA Fitness, Inc.
P.O. Box 2037
Jonesboro, AR 72402-2037

Product features or specifications as described or illustrated are subject to change without notice. All warranties are made by XTERRA Fitness, Inc. This warranty applies only in the 48 contiguous United States. NOTE: This does not apply to Alaska or Hawaii.

3000 Nestle Road Jonesboro, AR 72401 - Phone:870-336-4286 - Fax:870-935-7611