



SB500 FITNESS BIKE OWNER'S MANUAL

PLEASE CAREFULLY READ THIS ENTIRE MANUAL BEFORE OPERATING YOUR NEW FITNESS BIKE

Table Of Contents

Product Registration	1
Important Safety Instructions	2
Important Electrical Instructions	3
Important Operation Instructions	3
Features	3
SB500 Assembly Instructions	7
Operation of Your Console	11
General Maintenance	20
Manufacturer's Limited Warranty	21

ATTENTION

THIS FITNESS BIKE IS INTENDED FOR **RESIDENTIAL USE ONLY** AND IS WARRANTED FOR THIS APPLICATION. ANY OTHER APPLICATION **VOIDS** THIS WARRANTY IN ITS ENTIRETY.



Congratulations On Your New Fitness Bike and Welcome to the XTERRA Fitness Family!

Thank you for your purchase of this quality fitness bike from **XTERRA Fitness**. Your new fitness bike has been manufactured by one of the leading fitness manufacturers in the world. **XTERRA Fitness** will do all we can to make your ownership experience as pleasant as possible for many years to come. If you have questions, or if parts are missing or damaged, or you require customer service, call (870)336-4286. Please have your model number and serial number handy when you call.

Please take a moment to record where you purchased your machine, as well as the date of purchase for future reference. We appreciate your confidence in **XTERRA Fitness** and we will always remember that you are the reason that we are in business. Please complete and mail your registration card today and enjoy your new fitness bike.

Yours in Health,
XTERRA Fitness

Purchase Location _____

Purchase Date _____

Product Registration

Record Your Serial Number

Please record the Serial Number of this fitness product in the space provided below.

Serial Number _____

Register Your Purchase

The self-addressed product registration card must be completed in full and returned to **XTERRA Fitness**. You can also go to www.xterrafitnessstore.com/warrantyreg.html to register online.

Important Safety Instructions

When using an electrical appliance, basic precautions should always be followed, including the following:

Read all instructions before using this appliance.

DANGER - To reduce the risk of electric shock:

1. Always unplug this appliance from the electrical outlet immediately after using and before cleaning.

WARNING - To reduce the risk of burns, fire electric shock, or injury to persons:

1. An appliance should never be left unattended when plugged in. Unplug from outlet when not in use, and before putting on or taking off parts.
2. Do not operate under blanket or pillow. Excessive heating can occur and cause fire, electric shock, or injury to persons.
3. Close supervision is necessary when this appliance is used by, on, or near children, invalids, or disabled persons.
4. Use this appliance only for its intended use as described in this manual. Do not use attachments not recommended by the manufacturer.
5. Never operate this appliance if it has a damaged cord or plug, if it is not working properly, if it has been dropped or damaged, or dropped into water. Return the appliance to a service center for examination and repair.
6. Do not carry this appliance by supply cord or use cord as a handle.
7. Keep the cord away from heated surfaces.
8. Never operate the appliance with the air openings blocked. Keep the air openings free of lint, hair, and the like.
9. Never drop or insert any object into any opening.
10. Do not use outdoors.
11. Do not operate where aerosol (spray) products are being use or where oxygen is being administered.
12. Connect this appliance to a properly grounded outlet only.
13. The appliance is intended for household use.



WARNING: This product can expose you to chemicals including Toluene and Acrylamide which are known to the State of California to cause cancer and birth defects or other reproductive harm.

For more information go to www.P65Warnings.ca.gov

Fitness Equipment Safety Instructions

- To disconnect, turn all controls to the off position, then remove the plug from the outlet.
- Do not operate equipment on deeply padded, plush or shag carpet. Damage to both carpet and equipment may result.
- Before beginning this or any exercise program, consult a physician. This is especially important for persons over the age of 35 or persons with pre-existing health conditions.
- Keep hands away from all moving parts.
- The pulse sensors are not medical devices. Various factors, including the user's movement, may affect the accuracy of heart rate readings. The pulse sensors are intended only as exercise aids in determining heart rate trends in general.
- Do not attempt to use your equipment for any purpose other than for the purpose it is intended.
- Wear proper shoes. High heels, dress shoes, sandals or bare feet are not suitable for use on your equipment. Quality athletic shoes are recommended to avoid leg fatigue.

Failure to follow all guidelines may compromise the effectiveness of the exercise experience, expose yourself (and possibly others) to injury, and reduce the longevity of the equipment.

SAVE THESE INSTRUCTIONS - THINK SAFETY!

CAUTION!! Please be careful when unpacking the carton.

Important Electrical Instructions

WARNING!

- **NEVER** remove any cover without first disconnecting AC power supply.
- If A.C. voltage varies by ten percent (10%) or more, the performance of your fitness bike may be affected. Such conditions are not covered under your warranty. If you suspect the voltage is low, contact your local power company or a licensed electrician for proper testing.
- **NEVER** expose this fitness bike to rain or moisture. This product is NOT designed for use outdoors, near a pool or spa, or in any other high humidity environment. Maximum environmental ratings are 40-120 degrees Fahrenheit, 95% humidity non-condensing (no water droplets forming on surfaces).

Important Operation Instructions

- **NEVER** operate this fitness bike without reading and completely understanding the results of any operational change you request from the computer.
- Understand that changes in resistance do not occur immediately. Set your desired level on the computer console and release the adjustment key. The computer will obey the command gradually.
- **NEVER** use your fitness bike during an electrical storm. Surges may occur in your household power supply that could damage fitness bike components.
- Use caution while participating in other activities while using your fitness bike such as watching television, reading, etc. These distractions may cause you to lose balance, resulting in serious injury.

Features

Foot Pedals

Through research performed with a leading sports scientist and physical rehabilitation expert the engineers at Xterra have developed a breakthrough in pedal design. Typical stationary exercise bikes are wider than a normal road bike to allow for the braking mechanism, pulleys, drive components and beauty covers. Since the bike is wider, so is the distance between the pedals; this width between the pedals is called the Q factor.

Xterra has designed our pedal system so the Q factor is the smallest in the industry, but we did not stop there. We have also custom designed and tooled a new pedal that provides a two degree inward tilt to compensate for the Q factor not being perfect. Having a small Q factor in addition to the two degree inward tilt of the pedals puts the user into a biomechanical neutral alignment. This means that your feet, ankles, knees and hips are lined up properly so you can workout more comfortably for a longer time.

Transportation

The fitness bike is equipped with transport wheels, which are engaged when the rear of the fitness bike is lifted.

SB500 Assembly Pack Checklist

Hardware Step 1

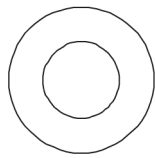

#70. 5/16" x 18mm
Flat Washer
(6 pcs)

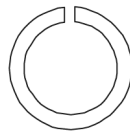

#73. 5/16"
Split Washer
(6 pcs)

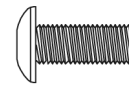

#81. M5 x 12mm
Phillips Head Screw
(4 pcs)

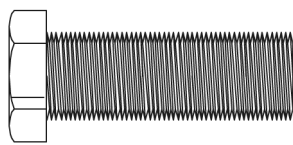

#90. 5/16" x 1-1/4"
Hex Head Bolt
(4 pcs)

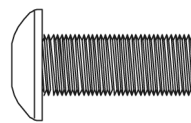

#95. 5/16" x 3/4"
Button Head Socket Bolt
(6 pcs)

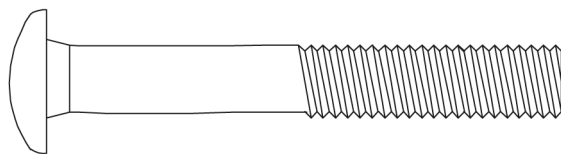

#96. 3/8" x 3-1/2"
Carriage Bolt
(2 pcs)

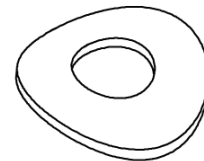

#97. 3/8" x 23mm
Curved Washer
(2 pcs)



#98. 3/8"
Cap Nut
(2 pcs)

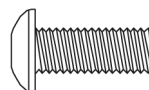

#99. M6 x 15mm
Phillips Head Screw
(4 pcs)

Hardware Step 2

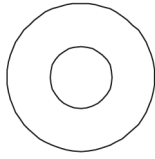

#71. 3/8" x 19mm
Flat Washer
(4 pcs)

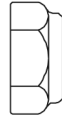

#80. 3/8"
Nyloc Nut
(4 pcs)

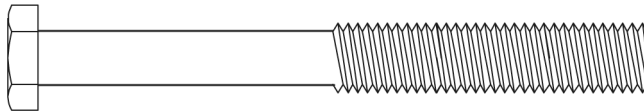

#100. 3/8" x 3"
Hex Head Bolt
(4 pcs)

Hardware Step 3

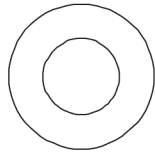

#70. 5/16" x 18mm
Flat Washer
(4 pcs)

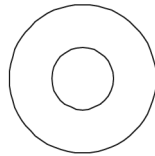

#71. 3/8" x 19mm
Flat Washer
(6 pcs)

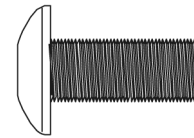

#95. 5/16" x 3/4"
Button Head Socket Bolt
(6 pcs)

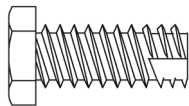

#101. 3/8" x 3/4"
Hex Head Bolt
(6 pcs)

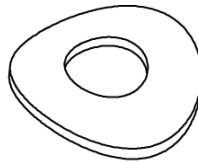

#102. 5/16" x 19mm
Curved Washer
(2 pcs)

Hardware Step 4

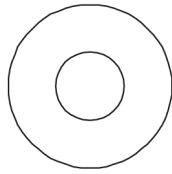

#70. 5/16" x 18mm
Flat Washer
(4 pcs)

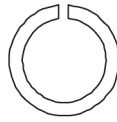

#73. 5/16"
Split Washer
(4 pcs)

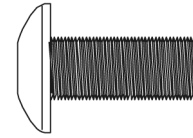

#95. 5/16" x 3/4"
Button Head Socket Bolt
(4 pcs)

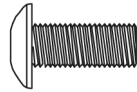

#81. M5 x 12mm
Phillips Head Screw
(4 pcs)

Assembly Tools

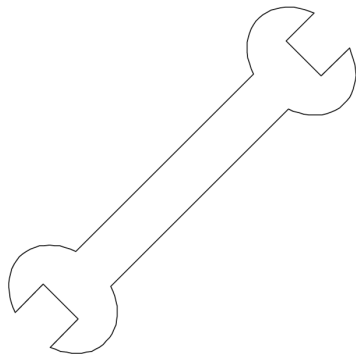

#103. 12/14mm Wrench

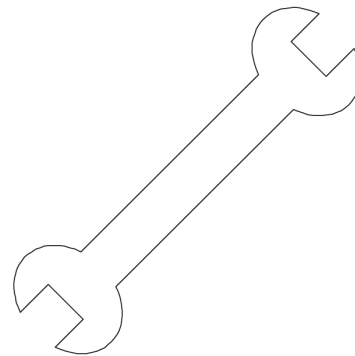

#104. 14/15mm Wrench

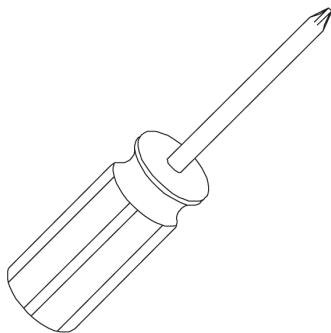

#105. Phillips
Head Screwdriver

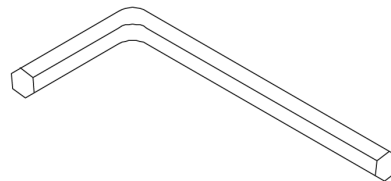

#106. M5 L Allen
Wrench

SB500 Assembly Instructions



Seat Assembly & Rear Stabilizer

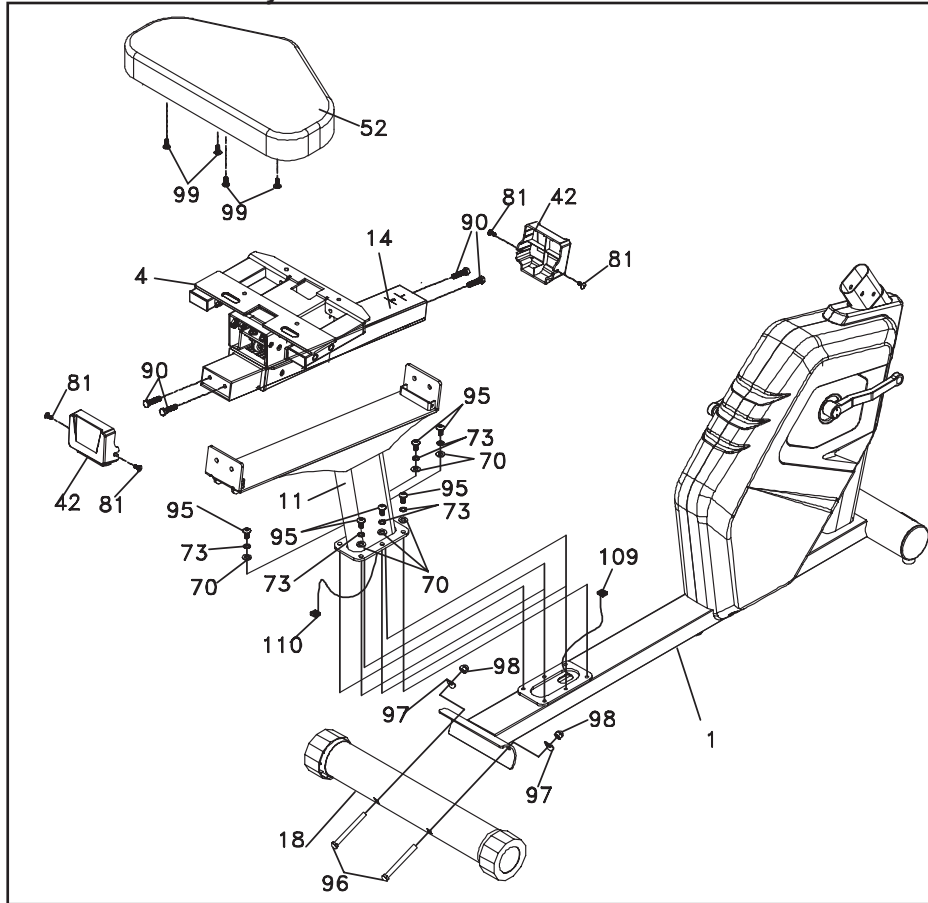

Hardware Step 1

- #70.** 5/16" x 18mm Flat Washer (6 pcs)
- #73.** 5/16" Split Washer (6 pcs)
- #81.** M5 x 12mm Phillips Head Screw (4 pcs)
- #90.** 5/16" x 1-1/4" Hex Head Bolt (4 pcs)
- #95.** 5/16" x 3/4" Button Head Socket Bolt (6 pcs)
- #96.** 3/8" x 3-1/2" Carriage Bolt (2 pcs)
- #97.** 3/8" x 23mm Curved Washer (2 pcs)
- #98.** 3/8" Cap Nut (2 pcs)
- #99.** M6 x 15mm Phillips Head Screw (4 pcs)

1. Install the Rear Stabilizer Tube (18) and secure with two Carriage Bolts (96), Curved Washers (97) and Cap Nuts (98).
2. Sitting next to the unit with the Seat Post (11) in your lap, connect the two wires together (109 & 110). Secure the Seat Post to the Main Frame be careful not to pinch the wires with the six Button Head Socket Bolts (95), Split Washers (73) and Flat Washers (70).
3. Lay the Seat Cushion (52) on the floor, cushion side down, and then lay the Seat Carriage Assembly (4 & 14) on top of the Seat Cushion. Align the holes and secure the Seat Cushion with four Phillips Head Screws (99). Make sure Seat Cushion is facing the right direction.
4. Secure the Seat Carriage Assembly (4 & 14) to the Seat Post with four Hex Head Bolts (90). Make sure these bolts are very tight. Assemble the plastic end caps (42) to the Seat Carriage with four Phillips Head Screws (81).

2 Rear Handle Bars

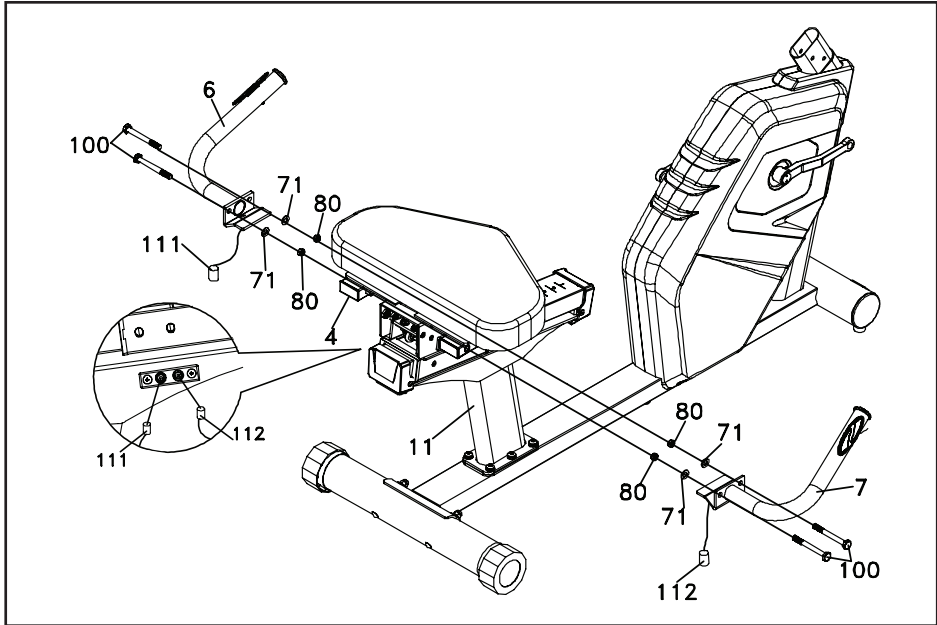

Hardware Step 2

- #71. 3/8" x 19mm Flat Washer (4 pcs)
- #80. 3/8" Nyloc Nut (4 pcs)
- #100. 3/8" x 3" Hex Head Bolt (4 pcs)

1. Install the Handlebars (6 & 7) to the Seat Carriage with four Hex Head Bolts (100), Flat Washers (71) and Nyloc Nuts (80). Be careful that the wires do not get pinched while assembling the handlebars. Connect Cable (111) to the Front Port on the left side below the seat, and Cable (112) to the Rear Port.

3 Console Mast & Seat Back

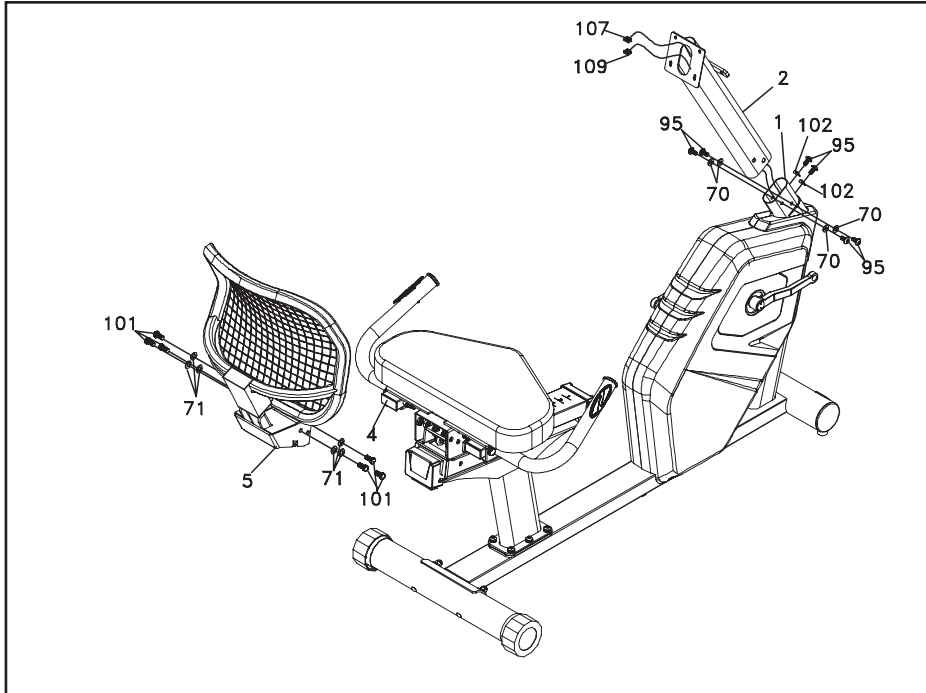

Hardware Step 3

- #70. 5/16" x 18mm Flat Washer (4 pcs)
- #71. 3/8" x 19mm Flat Washer (6 pcs)
- #95. 5/16" x 3/4" Button Head Socket Bolt (6 pcs)
- #101. 3/8" x 3/4" Hex Head Bolt (6 pcs)
- #102. 5/16" x 19mm Curved Washer (2 pcs)

1. Secure the Seat Back Assembly (5) to the Seat Carriage with six Hex Head Bolts (101) and Flat Washers (71). Make sure these bolts are very tight.
2. Run the two wires (107 & 109) through the bottom of the Console Mast and out the hole at the top. Slide the Console Mast into the mating tube; pull slightly on the two wires while you install the Console Mast so they do not get pinched. Secure the mast with six Button Head Socket Bolts (95), four Flat Washers (70) on the side bolts and two Curved Washers (102) on the two front bolts. Make sure to start all six bolts first before tightening all the way.

4

Console, Handle Bars & Pedals

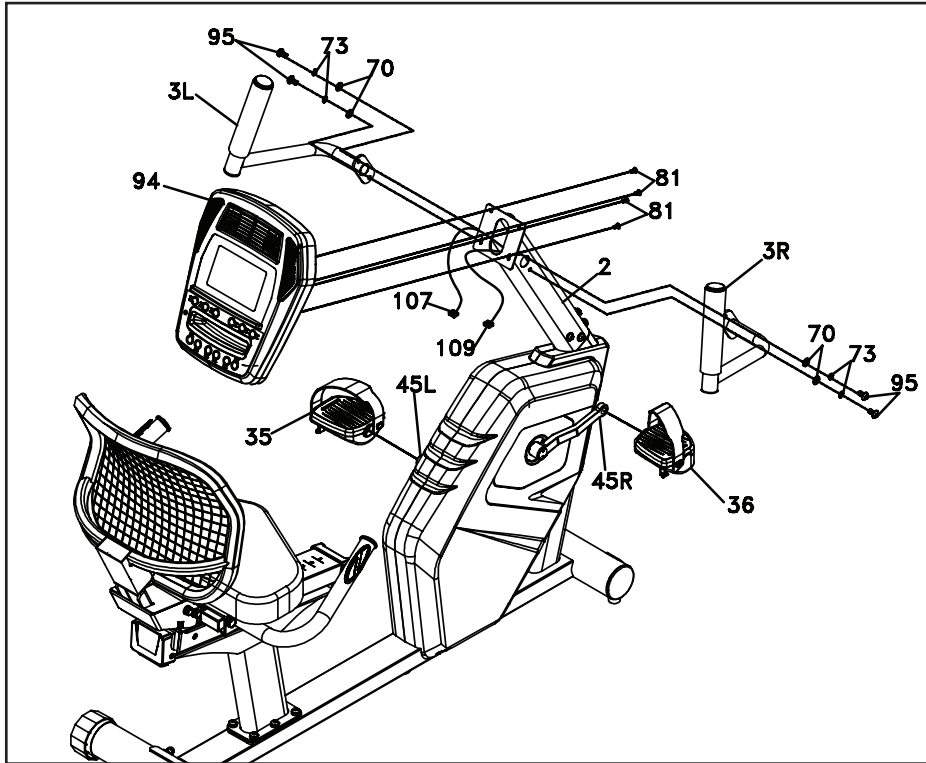

Hardware Step 4

- #70. 5/16" x 18mm Flat Washer (4 pcs)
- #73. 5/16" Split Washer (4 pcs)
- #95. 5/16" x 3/4" Button Head Socket Bolt (4 pcs)
- #81. M5 x 12mm Phillips Head Screw (4 pcs)

1. Install the Mast Handlebar Assembly (3L,3R) and secure with four Button Head Socket Bolts (95), Split Washers (73) and Flat Washers (70) by using the Allen Wrench (106).
2. Connect the two wires (107 & 109) to the mating connectors on the back of the Console Assembly (94) and secure the console with four Phillips Head Screws (81) by using Phillips Head Screw Driver (105). Be careful not to pinch the wires between the console and mounting plate.
3. Install the two pedals onto the crank arms. The left pedal (35) is a reverse thread so as you turn the pedal bolt into the crank arm turn it counter-clockwise as if you are loosening it. The right side pedal (36) is a normal thread so tighten it clockwise. Make sure the pedals are as tight as you can possibly get them. It may be necessary to re-tighten them again after a few hours of use.

Operation of Your Console

SB500 Console

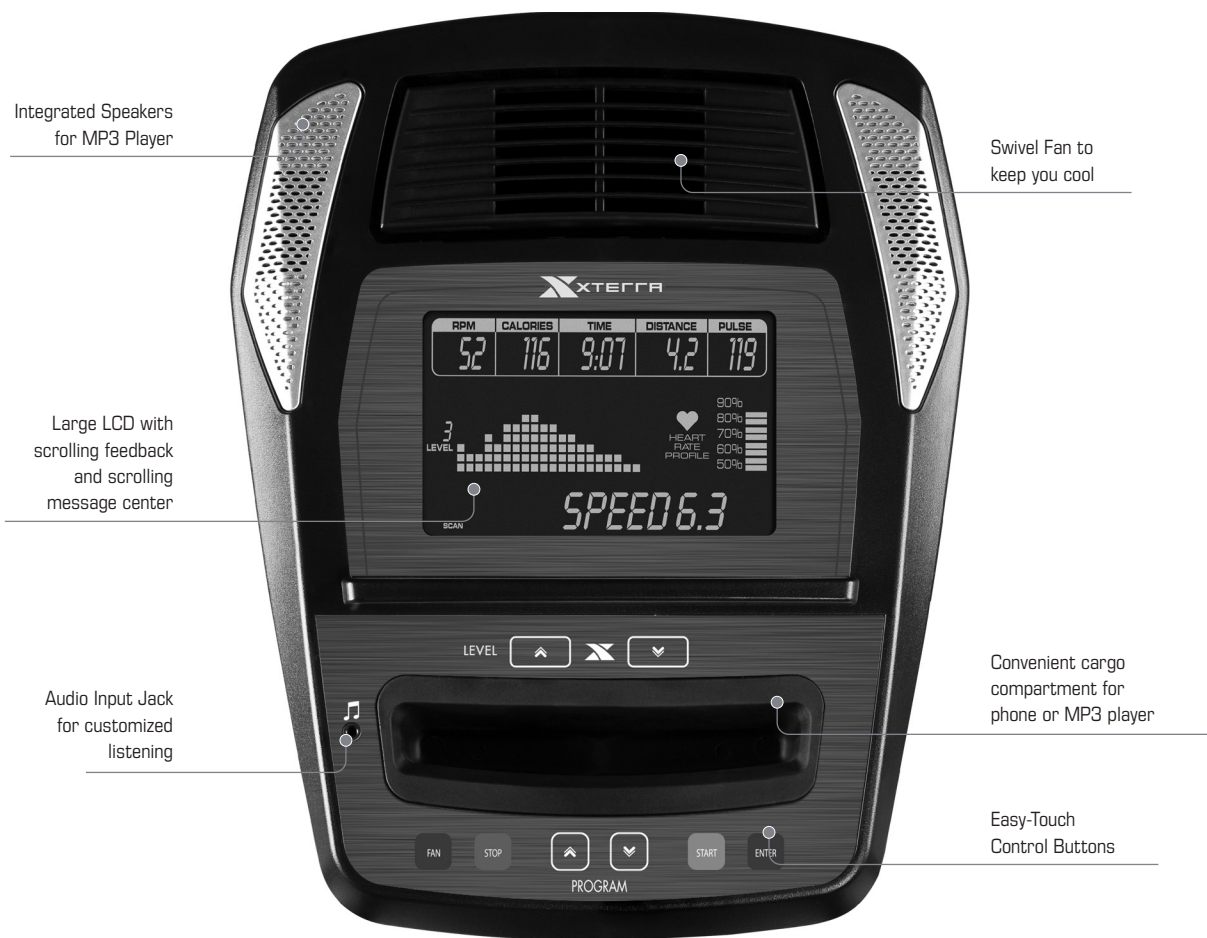

Power Up

The SB500 fitness bike is supplied with an external power supply. When power is connected to the fitness bike, the console will automatically power up. If there is no input to the console for 20 minutes, the console will go to stand-by mode to save energy. To turn the console on press any key.

When initially powered on the console will perform an internal self-test. During this time all the lights will turn on. When the lights go off the dot matrix display will show a software version (i.e.: VER 1.0) and the time and distance windows will display an odometer reading. The odometer reading displays how many hours the fitness bike has been used and how many virtual miles the fitness bike has gone.

The odometer will remain displayed for only a few seconds then the console will go to the start up display. The dot matrix display will be scrolling through the different workout profiles of the programs and operating instructions. You may now begin to use the console.

Console Operation

Quick Start Mode

This is the quickest way to start a workout. After the console powers up, press the **Start** key to begin. In Quick Start the time will count up from zero and the Resistance may be adjusted manually by pressing the **Level** \blacktriangle / \blacktriangledown keys.

Basic Information and Functions:

Display:

The dot matrix display will show the Resistance profile. If you press the **Start** key during a program, the display will switch to a Lap track, which is $\frac{1}{4}$ mile in length.

Pressing the **Enter** key will switch the data displayed in the Message Window. Initially, the Message Window shows the program name. Each time the **Enter** key is pressed the data will change to the following: Speed, Watts, Laps, Current Level/Max Level, Scan, and repeat sequence. To the left of the dot matrix is a number that indicates your Resistance level.

Data Displayed:

- Calories show an accumulation of calories burned (Kcal). This is an estimate that takes into account the type of exercise, the resistance level, the pace and body weight.
- Time shows elapsed time if counting up from zero, or time remaining if counting down.
- Pulse indicates your heart rate if you are grasping the hand pulse sensors.
- RPM displays your pedaling speed in revolutions per minute.
- Speed shows your speed in miles per hour or kilometers per hour if 'Km' is displayed.
- Distance displays accumulated mileage.

The fitness bike has a built in Heart Rate Monitoring System. Simply grasping the hand pulse sensors on the stationary handlebars or by wearing the chest strap will start the heart icon blinking (this may take a few seconds). The Pulse Display Window will display your heart rate, or pulse, in beats per minute.

Pause/Reset Functions:

The **Stop/Reset** key actually has several functions. Pressing the **Stop/Reset** key once during a program will pause the program for five minutes. If you need to get a drink, answer the phone or any of the many things that could interrupt your workout, this is a great feature. To resume your workout after pausing just press the **Start** key. If the **Stop/Reset** key is pressed twice during a workout, the program will end and a summary of your workout will be displayed. If the **Stop/Reset** key is held down for three seconds, the console will perform a complete reset.

Audio System:

There is an Audio Input Jack on the front of the console, and built-in speakers. You may plug any low-level audio source signal into this port. Audio sources include: MP3 player, iPod, portable radio, CD player or even a TV or computer.

Programming The Console

Each of the programs can be customized with your personal information and changed to suit your needs. Some of the information asked for during programming is necessary to ensure the readouts are correct. You will be asked for your age and weight. Entering your age is necessary during the Heart Rate Program to ensure the correct settings are entered in the program. Entering your Weight helps calculate a more accurate calorie reading; although we cannot provide an exact calorie count we do want to be as close as possible.

Calorie Note: Calorie readings on every piece of exercise equipment, whether it is in a gym or at home, are estimates. They are meant only as a guide to monitor your progress from workout to workout. The only way to measure your calorie burn accurately is in a clinical setting. This is because each individual is different and burns calories at a different rate.

Entering a Program/Changing Settings

Press the program keys to scroll through the program selections. The profile for each program will be displayed in the dot matrix window. Press the **Enter** key to select a program and begin customizing the settings. If you want to workout without entering new settings, press the **Start** key. This will bypass the programming of data and take you directly to the start of your workout. If you want to change the personal settings, follow the instructions in the message window. If you start a program without changing the settings, the default settings will be used.

Note: Age and Weight default settings will change when you enter a new number. The last age and weight entered will be saved as the new default settings. If you enter an age and weight the first time you use the fitness bike you will not have to enter it every time you work out unless either your age or weight changes or someone else enters a different age and weight.

Manual Program

The Manual program allows you to adjust your workload throughout the workout to meet your personal fitness needs.

1. Press the **Program** ▲/▼ key until the message window shows MANUAL. Press the **Enter** key to continue.
2. The message window will ask you to enter your Age. Adjust the Age setting using the **Level** ▲/▼ keys. Press **Enter** to continue.
3. The message window will ask you to enter your Weight. Adjust the Weight setting using the **Level** ▲/▼ keys. Press the **Enter** key to accept the new number and proceed on to the next screen.
4. Next is the Time. Adjust the Time and press **Enter** to continue.
5. Now you are finished editing the settings and can begin your workout by pressing the **Start** key.
6. Once the program starts the fitness bike will be set to level one for Resistance. If you want to increase the work load at any time press the **Level** ▲ key on the console; the **Level** ▼ key will decrease the workload.
7. During the Manual program you will be able to switch data displayed in the message window by pressing the **Enter** key.
8. When the program ends the message window will show a summary of your workout. The summary will be displayed for a short time before the console returns to the start-up display.

Programming Preset Programs

1. Using the **Program** ▲/▼ keys, select the desired program then press the **Enter** key.
2. The Message Window will ask you to enter your Age. Adjust the Age setting, using the **Level** ▲/▼ keys. Press the **Enter** key to accept the new number and proceed on to the next screen.
3. You are now asked to enter your Weight. Adjust the Weight setting using the **Level** ▲/▼ keys. Press **Enter** to continue.
4. Next is Time. Adjust the Time setting using the **Level** ▲/▼ keys. Press **Enter** to continue.
5. Now you are asked to adjust the Max Level. This is the peak exertion level you will experience during the program (work level at the top of the hill). Adjust the level and then press **Enter**.
6. Now you are finished editing the settings and can begin your workout by pressing the **Start** key.
7. If you want to increase or decrease the workload at any time during the program, press the **Level** ▲/▼ keys. This will change only the work level during the current segment.
8. During the program you will be able to switch the data displayed by pressing the **Enter** key.
9. When the program ends the message window will show a summary of your workout. The summary will be displayed for a short time before the console returns to the start-up display.

Preset Programs

The SB500 has seven different programs that have been designed to provide a variety of workouts. These programs have factory preset profiles for achieving different goals.

Ascent - Work Profile

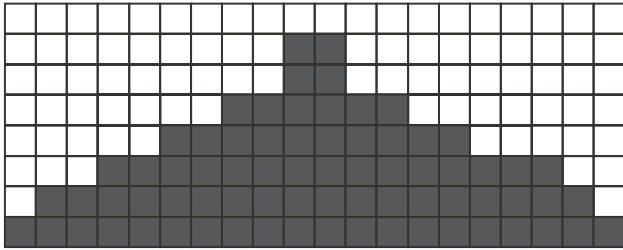

Fat Burn - Work Profile

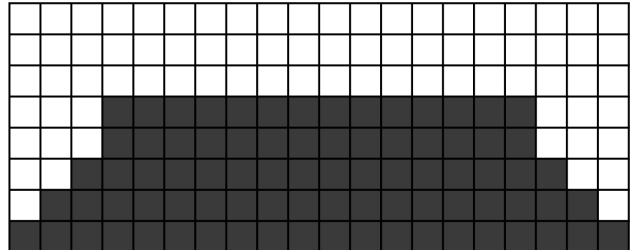

Glute Blast - Work Profile

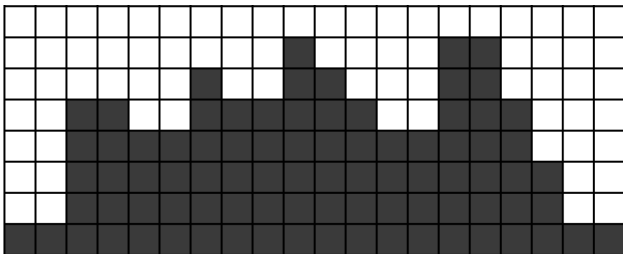

Adventure - Work Profile

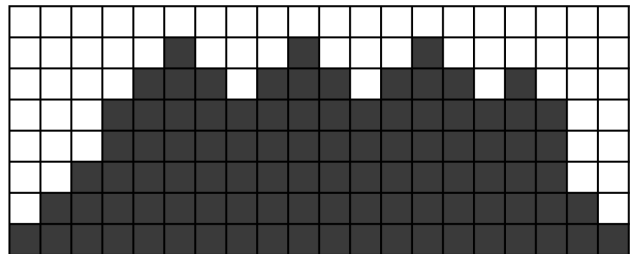

Xtreme - Work Profile

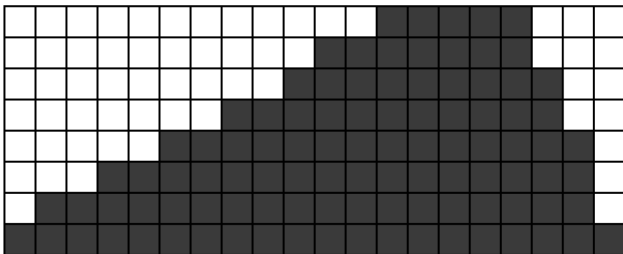

Interval - Work Profile

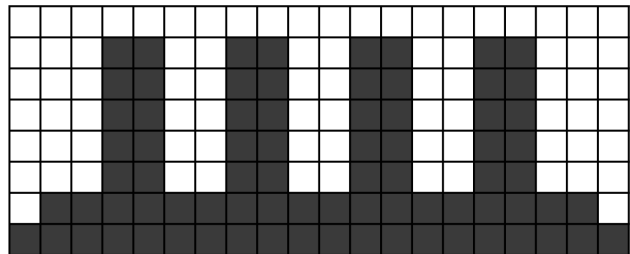

X Country - Work Profile

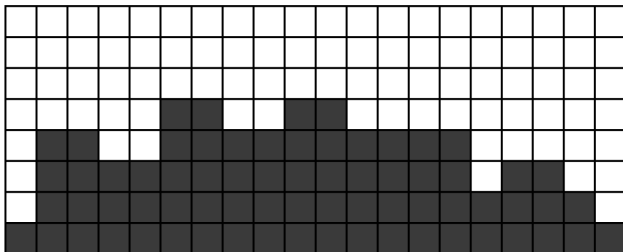

User Programs

The User Programs allow you to build and save your own workout. You can build your own custom program by following the instructions below.

1. Select the User Program (User 1 or User 2) using the **Program** ▲/▼ arrows then press **Enter**. The message will ask “Run Program?” if there is already a program stored. Use the **Level** ▲/▼ key to change between “Yes” or “NO”. If you want to run the program as it is, go to “Yes” and press **Enter** or **Start** to begin stored program. If No is selected, you have the option to cancel the stored program and create your own program. Press **Enter** to cancel and create your own.
2. If you cancel the stored program or there isn't a program stored, the letter “A” will be flashing. Use the **Level** ▲/▼ keys to select the first letter of your name. Press **Enter**. Repeat this process until the last letter of your name is flashing. Press **Stop** to accept your User name.
3. The message window will ask you to enter your Age. Enter your Age using the **Level** ▲/▼ keys. Press the **Enter** key to accept the new number and proceed on to the next screen.
4. You are now asked to enter your Weight. Adjust the Weight setting using the **Level** ▲/▼ keys. Press **Enter** to continue.
5. Next is Time. Adjust the total program time using the **Level** ▲/▼ keys. Press **Enter** to continue.
6. Next is the Top Level setting. You may adjust the Top Level and press **Enter** to continue.
7. Now the message window will ask you to adjust the first segment level for Resistance; use the **Level** ▲/▼ keys to adjust. When you finish adjusting the first segment, or if you don't want to change it, then press **Enter** to continue to the next segment.
8. The next segment will show the same level as the previously adjusted segment. Repeat the same process as the last segment then press **Enter**. Continue this process until all twenty segments have been set.
9. The message window will ask you to press **Enter** to save the program. After saving the program, press **Start** to begin.
10. If you want to adjust the Resistance at any time during the program, press the **Level** ▲/▼ keys.
11. When the program ends the message window will show a summary of your workout. The summary will be displayed for a short time then the console will return to the start-up display.

Heart Rate Programs

Note: You must grasp the contact heart rate grips with both hands or use the telemetric heart rate strap when using these programs. Both programs operate the same. The only difference is that HR1 is set to 60% and HR2 is set to 80% of your maximum heart rate.

To start a Heart Rate Program, follow the instructions below.

1. Press the **Program** ▲/▼ keys until message window displays HR1 or HR2. Press **Enter** to select.
2. The message window will ask you to enter your Age. Enter your Age using the **Level** ▲/▼ keys then press the **Enter** key to accept the new number and proceed.
3. You are now asked to enter your Weight. Adjust the Weight setting using the **Level** ▲/▼ keys.
4. Next is time. Adjust the Time setting using the **Level** ▲/▼ keys. Press **Enter** to continue.
5. You are now asked to select the Target Heart Rate Level. Adjust the target level and then press **Enter**. During the workout the product will adjust resistance to keep you near this heart rate.
6. Now you are finished editing the settings and can begin your workout by pressing the **Start** key. You can also go back and modify your settings by pressing the **Stop** key to go back one level, or screen.
7. If you want to increase or decrease the target heart rate at any time during the program press the **Level** ▲/▼ keys.

Heart Rate

The old motto, “no pain, no gain”, is a myth that has been overpowered by the benefits of exercising comfortably. A great deal of this success has been promoted by the use of heart rate monitors. With the proper use of a heart rate monitor, many people find that their usual choice of exercise intensity was either too high or too low and exercise is much more enjoyable by maintaining their heart rate in the desired benefit range.

To determine the benefit range in which you wish to train, you must first determine your predicted Maximum Heart Rate. This can be accomplished by using the following formula: 220 minus your age. This will give you the predicted Maximum Heart Rate (MHR) for someone of your age. To determine the effective heart rate range for specific goals you simply calculate a percentage of your MHR. Your heart rate training zone is 50% to 90% of your maximum heart rate. 60% of your MHR is the zone that burns fat, while 80% is for strengthening the cardio vascular system. This 60% to 80% is the zone to stay in for maximum benefit.

For someone who is 40 years old their predicted target heart rate zone is calculated:

$$\begin{aligned} 220 - 40 &= 180 \text{ (maximum heart rate)} \\ 180 \times .6 &= 108 \text{ beats per minute} \\ &\text{(60\% of maximum)} \\ 180 \times .8 &= 144 \text{ beats per minute} \\ &\text{(80\% of maximum)} \end{aligned}$$

So for a 40 year old the training zone would be 108 to 144 beats per minute.

If you enter your age during programming the console will perform this calculation automatically. After calculating your MHR you can decide upon which goal you would like to pursue.

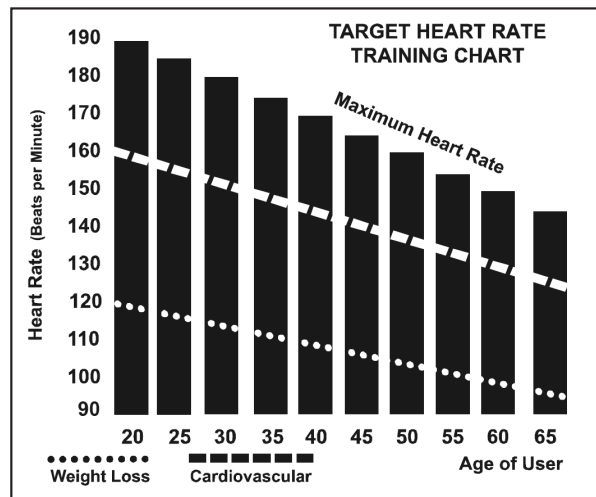

The two most popular reasons for, or goals, of exercise are cardiovascular fitness (training for the heart and lungs) and weight control. The black columns on the chart above represent the MHR for a person whose age is listed at the bottom of each column. The training heart rate, for either cardiovascular fitness or weight loss, is represented by two different lines that cut diagonally through the chart. A definition of the lines' goal is in the bottom left-hand corner of the chart. If your goal is cardiovascular fitness or if it is weight loss, it can be achieved by training at 80% or 60%, respectively, of your MHR on a schedule approved by your physician. Consult your physician before participating in any exercise program.

Rate of Perceived Exertion

Heart rate is important but listening to your body also has a lot of advantages. There are more variables involved in how hard you should workout than just heart rate. Your stress level, physical health, emotional health, temperature, humidity, the time of day, the last time you ate and what you ate all contribute to the intensity at which you should workout. If you listen to your body it will tell you all of these things.

The rate of perceived exertion (RPE), also known as the Borg scale, was developed by Swedish physiologist G.A.V. Borg. This scale rates exercise intensity from 6 to 20 depending upon how you feel or the perception of your effort.

The scale is as follows:

Rating Perception of Effort

- 6 Minimal
- 7 Very,very light
- 8 Very,very light +
- 9 Very light
- 10 Very light +
- 11 Fairly light
- 12 Comfortable
- 13 Somewhat hard
- 14 Somewhat hard +
- 15 Hard
- 16 Hard +
- 17 Very hard
- 18 Very hard +
- 19 Very,very hard
- 20 Maximal

You can get an approximate heart rate level for each rating by simply adding a zero to each rating. For example a rating of 12 will result in an approximate heart rate of 120 beats per minute. Your RPE will vary depending on the factors discussed earlier. If your body is strong and rested, you will feel strong and your pace will feel comfortable. When your body is in this condition, you are able to train harder and the RPE will support this. If you are feeling tired and sluggish, it is because your body needs a break. In this condition, your pace will feel difficult. Again, this will show up in your RPE and you will train at the proper level for that day.

Wearing The Chest Strap

1. Attach the transmitter to the elastic strap using the interlocking button.
2. Adjust the strap as tightly as possible as long as the strap is not too tight to remain comfortable.
3. Position the transmitter with the logo centered in the middle of your torso facing away from your chest (some people must position the transmitter slightly left of center). Attach the final end of the elastic strap by inserting the round end and, using the locking parts, secure the transmitter and strap around your chest.
4. Position the transmitter directly below the pectoral muscles.
5. Sweat is the best conductor to measure very minute heart beat electrical signals. However, plain water can also be used to pre-wet the electrodes (2 ribbed oval areas on the reverse side of the belt and both sides of the transmitter). It's also recommended that you wear the transmitter strap a few minutes before your work out. Some users, because of body chemistry, have a more difficult time in achieving a strong, steady signal at the beginning. After "warming up", this problem lessens.
6. Your workout must be within range - distance between transmitter/receiver – to achieve a strong steady signal. The length of range may vary somewhat but generally stay close enough to the console to maintain good, strong, reliable readings. Wearing the transmitter directly on bare skin assures you of proper operation. If you wish, you may wear the transmitter over a shirt. To do so, wet the areas of the shirt that the electrodes will rest upon.

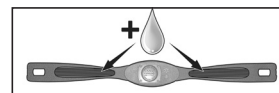
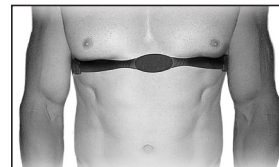

Note: The transmitter is automatically activated when it detects activity from the user's heart. Additionally, it automatically deactivates when it does not receive any activity. Although the transmitter is water resistant, moisture can have the effect of creating false signals, so you should take precautions to completely dry the transmitter after use to prolong battery life (estimated transmitter battery life is 2500 hours).

Erratic Operation

Caution! Do not use this product for heart rate programs unless a steady, solid actual heart rate value is being displayed. High, wild, random numbers being displayed indicate a problem.

Areas to look for interference which may cause erratic heart rate:

1. Microwave ovens, TV's, small appliances, etc.
2. Fluorescent lights.
3. Some household security systems.
4. Perimeter fence for a pet.
5. Some people have problems with the transmitter picking up a signal from their skin. If you have problems try wearing the transmitter upside down. Normally the transmitter will be oriented so the XTERRA Fitness logo is right side up.
6. The receiver that picks up your heart rate is very sensitive. If there is an outside noise source, turning the whole machine 90 degrees may de-tune the interference.
7. Another Individual wearing a transmitter within 3' of your machine's console.

If you continue to experience problems contact your us.

General Maintenance

1. Wipe down all areas in the sweat path with a damp cloth after each workout.
2. If a thump, clicking or wobbly feeling develops, the main cause is usually the pedals and/or crank arms being loose.

Engineering Mode

The console has built in maintenance/diagnostic software. The software will allow you to make changes to the console settings such as changing units from English to Metric or turning off the console beeps (if they are waking your family during your early morning workouts). To enter the Maintenance Menu (may be called Engineering Mode, depending on version) press and hold down the **Start**, **Stop** and **Enter** keys. Keep holding the keys down for about five seconds and the message window will display "Engineering Mode". Press the **Enter** key to access the menu below. Press the **Resistance Up/Down** keys to navigate the menu.

- a. Key Test - Allows you to test all the keys to make sure they are functioning
- b. LCD Test - Tests all of the display functions
- c. Functions - Press **Enter** to access settings, use **Resistance Up/Down** keys to navigate.
 - i. Sleep Mode - On; when turned on the console will darken after 30 minutes of no use. When turned off the console will remain lit as long as the power is on
 - ii. Motor Test - Continually runs the tensioning gear motor
 - iii. Manual - Allows stepping of the gear motor
 - iv. TYPE SET - Set to Bike or Elliptical
 - v. Key Tone - Turns on/off the key press beeping tones
 - vi. Units - Set to English or Metric display readings
 - vii. Odometer Reset - Reset the odometer
 - viii. Pause mode – On; when turned off, pressing **Stop** once ends the program; when turned on, the console retains data for five minutes before switching to the startup screen
 - ix. Safety – Off; when turned on the machine automatically goes to **Level 20** of Resistance to prevent unauthorized use by a child
- d. Security - Allows you to lock the keypad so no unauthorized use is allowed. When the child lock is enabled, the console will not allow the keypad to operate unless you press and hold the **Start** and **Enter** keys for three seconds to unlock the console.
- e. Factory Set
- f. Exit – press **Enter** to return to the startup screen

Manufacturer's Limited Warranty

Effective July 06, 2020 - FITNESS BIKE LIMITED WARRANTY

XTERRA Fitness Inc. warrants all its home use fitness bike parts for a period of time listed below, from the date of retail sale, as determined by a sales receipt or in the absence of a sales receipt, eighteen (18) months from the original factory shipping date. XTERRA Fitness' responsibilities include providing new or remanufactured parts, at XTERRA Fitness' option, and technical support to our independent dealers and servicing organizations. In the absence of a dealer or service organization, these warranties will be administered by XTERRA Fitness directly to a consumer. The warranty period applies to the following components:

Home Use Limited Warranty

Frame & Brake	Parts	In-Home Labor
Lifetime	3 Years	1 Year

NORMAL RESPONSIBILITIES OF THE CONSUMER

This warranty applies only to products in ordinary household use. The consumer is responsible for the items listed below:

1. The warranty registration card must be completed and returned to the address listed on the card within 10 days of the original purchase to validate the manufacturer's limited warranty or register online at the XTERRA Fitness website.
2. Proper use of the fitness bike in accordance with the instructions provided in this manual, including maintenance.
3. Proper connection to a power supply of sufficient voltage, replacement of blown fuses, repair of loose connections or defects in house/facility wiring.
4. Expenses for making the fitness bike accessible for servicing, including any item that was not part of the fitness bike at the time it was shipped from the factory.
5. Damages to the fitness bike finish during shipping, installation or following installation.

EXCLUSIONS

This warranty does not cover the following:

1. CONSEQUENTIAL, COLLATERAL, OR INCIDENTAL DAMAGES SUCH AS PROPERTY DAMAGE AND INCIDENTAL EXPENSES RESULTING FROM ANY BREACH OF THIS WRITTEN OR ANY IMPLIED WARRANTY. Note: Some states do not allow the exclusion or limitation of incidental or consequential damages, so this limitation or exclusion may not apply to you.
2. Service call reimbursement to the consumer. Service call reimbursement to the dealer that does not involve malfunction or defects in workmanship or material, for units that are beyond the warranty period, for units that are beyond the service call reimbursement period, for fitness bikes not requiring component replacement, or fitness bikes not in ordinary household use.
3. Damages caused by services performed by persons other than authorized XTERRA Fitness service companies, use of parts other than original XTERRA Fitness parts, or external causes such as alterations, modifications, abuse, misuse, accident, improper maintenance, inadequate power supply, or acts of God.
4. Products with original serial numbers that have been removed or altered.
5. Products that have been; sold, transferred, bartered, or given to a third party.
6. Products that are used as store display models.
7. Products that do not have a warranty registration on file at XTERRA Fitness Inc. XTERRA Fitness reserves the right to request proof of purchase if no warranty record exists for the product.
8. Product use in any environment other than a residential setting.
9. THIS WARRANTY IS EXPRESSLY IN LIEU OF ALL OTHER WARRANTIES EXPRESSED OR IMPLIED, INCLUDING THE WARRANTIES OF MERCHANTABILITY AND/OR FITNESS FOR A PARTICULAR PURPOSE.

SERVICE

Keep your bill of sale. Twelve (12) months from the date on the bill of sale or eighteen (18) months from the date of factory shipping as determined by the serial number establishes the warranty period should service be required. If service is performed, it is in your best interest to obtain and keep all receipts. This written warranty gives you specific legal rights. You may also have other rights that vary from state to state. Service under this warranty must be obtained by following these steps, in order:

1. Contact your selling authorized XTERRA Fitness dealer. OR
2. Contact your local authorized XTERRA Fitness service organization.
3. If there is a question as to where to obtain service, contact our service department at (870)336-4286.
4. XTERRA Fitness' obligation under this warranty is limited to repairing or replacing, at XTERRA Fitness' option, the product through one of our authorized service centers. All repairs must be preauthorized by XTERRA Fitness. If the product is shipped to a service center freight charges to and from the service center will be the customer's responsibility. For replacement parts shipped while the product is under warranty, the customer will be responsible for shipping and handling charges. For in-home service, the customer will be responsible for a trip charge. There will be an additional trip charge if the customer is located over 100 miles from the nearest service center.
5. The owner is responsible for adequate packaging upon return to XTERRA Fitness. XTERRA Fitness is not responsible for damages in shipping. Make all freight damage claims with the appropriate freight carrier. DO NOT SHIP ANY UNIT TO OUR FACTORY WITHOUT A RETURN AUTHORIZATION NUMBER. All units arriving without a return authorization number will be refused.
6. For any further information, or to contact our service department by mail, send your correspondence to:

XTERRA Fitness, Inc.
P.O. Box 2037
Jonesboro, AR 72402-2037

Product features or specifications as described or illustrated are subject to change without notice. All warranties are made by XTERRA Fitness, Inc. This warranty applies only in the 48 contiguous United States. NOTE: This does not apply to Alaska or Hawaii.

3000 Nestle Road Jonesboro, AR 72401 - Phone:870-336-4286 - Fax:870-935-7611

www.xterrafitnessstore.com

©2018 All Rights Reserved. SB500 Owner's Manual